

AMS Confidential

4 x 6.5 inches (101.6 mm x 165.1 mm)

ARTERIOCYTE
*CELLULAR THERAPIES
MEDICAL SYSTEMS*

MAGELLAN[®]
Ratio Dispenser Kit

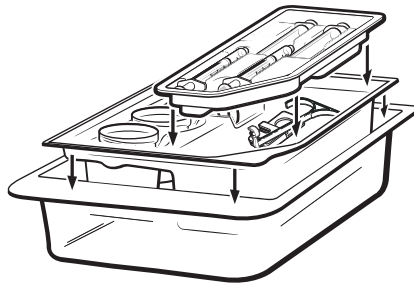

Instructions For Use

AMS95125LBL Rev. 2

AMS Confidential

4 x 6.5 inches (101.6 mm x 165.1 mm)

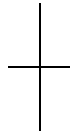
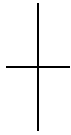
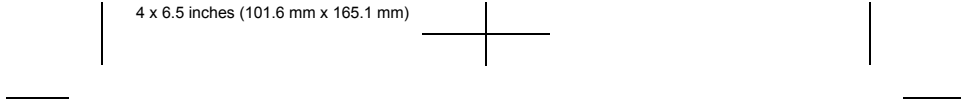













AMS95125LBL Rev. 2



4 x 6.5 inches (101.6 mm x 165.1 mm)

Explanation of symbols on package labeling

	Caution, Consult Accompanying Documents
	Lot Number
	Catalog Number
	Sterilized Using Ethylene Oxide
	Latex Free
	Nonpyrogenic
	Do Not Reuse
	Use By
	Open Here
	Fragile, Handle with Care
	This Way Up
	Quantity
	For US Audiences Only

4 x 6.5 inches (101.6 mm x 165.1 mm)

AMS Confidential

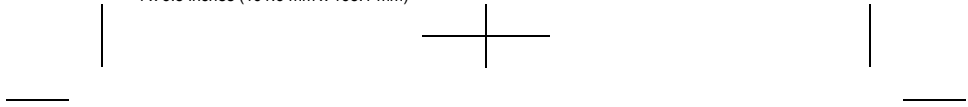

2

AMS95125LBL Rev. 2

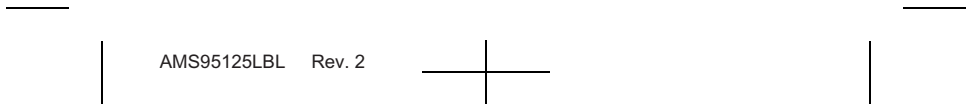

4 x 6.5 inches (101.6 mm x 165.1 mm)

INTRODUCTION

The Arterioocyte Medical Systems, Inc. Magellan® Ratio Dispenser Kit consists of single use components to be used in conjunction with a Arterioocyte Medical Systems, Inc. Magellan® Dispenser Tip.

Intended use

The components of this Arterioocyte Medical Systems, Inc. Magellan® Ratio Dispenser Kit, when used with a tip, are intended to assist the user in simultaneously delivering two non-homogenous liquids to the same treatment area(s).

The Magellan® Ratio Dispenser Kit is intended for the application of fluids, as deemed necessary by the surgeon's determination of the clinical use requirements, to facilitate the preparation of soft tissue prior to repair.

Warning: Reprocessing may compromise the structural integrity of the device and/or lead to device failure. Reuse of this single patient use device creates a potential risk of patient or user infections. Contamination of the device may lead to injury, illness or death of the patient.

How Supplied

All components are shipped sterile.

The Magellan® Ratio Dispenser Kit consists of the following components:

- One (1) procedure tray
- Three (3) 60-mL sample cups with lids
- Two (2) 12-mL syringes
- Two (2) 1-mL syringes
- Two (2) dispenser handles
- Two (2) dual syringe plunger clips

Accessories

One (1) Magellan® Dispenser Tip is required for the use of this dispenser kit.

Dispenser Tips are available from Arterioocyte Medical Systems.

Cautions

! USA Caution: Federal law (USA) restricts this device to sale by or on the order of a physician.

Kit components are for single use only. Do not resterilize.

INSTRUCTIONS

1. Using aseptic technique, remove the components of the dispenser kit from the sterile package and a dispenser tip from its sterile package.
2. Fill the larger 12-mL syringe with liquid.
3. Fill the smaller 1-mL syringe with a second liquid to approximately the same level.

AMS Confidential

4 x 6.5 inches (101.6 mm x 165.1 mm)

4. Snap the dispenser handle to the 12mL syringe (see Figure 1, number 1).
5. Attach each syringe to the dispenser tip (see Figure 1, numbers 2 and 3).
6. Snap the plunger clip to both syringe plungers (see Figure 1, number 4).
Figure 2 shows the assembled dispenser.
7. Depress the syringe plunger clip to dispense the desired volume of the two liquids.

4 English Instructions for Use

AMS95125LBL Rev. 2

4 x 6.5 inches (101.6 mm x 165.1 mm)

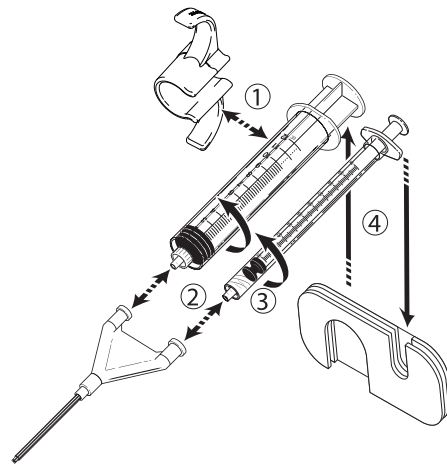

Figure 1.

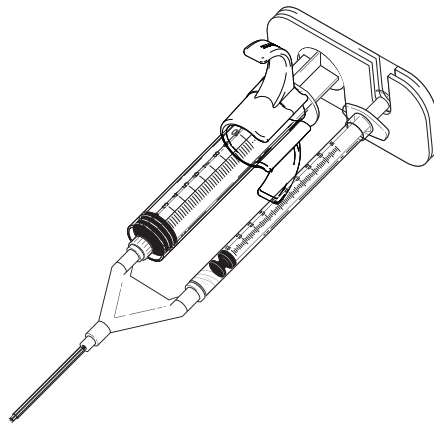

Figure 2.

4 x 6.5 inches (101.6 mm x 165.1 mm)

**ARTERIOCYTE MEDICAL SYSTEMS INC. DISPOSABLES
KIT LIMITED WARRANTY¹ (U.S.)**

**THE FOLLOWING LIMITED WARRANTY APPLIES TO UNITED STATES
CUSTOMERS ONLY:**

- A. This Limited Warranty provides the following assurance to the customer who receives the **Arterioocyte Medical Systems, Inc. Magellan[®]Ratio Dispenser Kit**, hereafter referred to as the "Product":
- (1) Should the Product fail to function within normal tolerances due to a defect in materials or workmanship prior to its "Use Before Date", Arterioocyte Medical Systems will at its option: (a) issue a credit equal to the Purchase Price, as defined in Subsection A(2), against the purchase of the replacement Product or (b) provide a functionally comparable replacement Product at no charge.
 - (2) As used herein, Purchase Price shall mean the lesser of the net invoiced price of the original, or current functionally comparable, or replacement Product.
- B. To qualify for the Limited Warranty, these conditions must be met:
- (1) The Product must be used prior to its "Use By" date.
 - (2) The unused portion of the Product must be returned to Arterioocyte Medical Systems and within 60 days after use and shall be the property of Arterioocyte Medical Systems.
 - (3) The Product must not have been altered or subjected to misuse, abuse or accident.
 - (4) The Product may not have been used by any other customer.
- C. This Limited Warranty is limited to its express terms. In particular:
- (1) Except as expressly provided by this Limited Warranty, ARTERIOCYTE MEDICAL SYSTEMS IS NOT RESPONSIBLE FOR ANY DIRECT, INCIDENTAL OR CONSEQUENTIAL DAMAGES BASED ON ANY DEFECT, FAILURE OR MALFUNCTION OF THE PRODUCT, WHETHER THE CLAIM IS BASED ON WARRANTY, CONTRACT, TORT OR OTHERWISE.
 - (2) This Limited Warranty is made only to the customer in whom the Product was used. AS TO ALL OTHERS, ARTERIOCYTE MEDICAL SYSTEMS MAKES NO WARRANTY, EXPRESS OR IMPLIED, INCLUDING, BUT NOT LIMITED TO, ANY IMPLIED WARRANTY OF MERCHANTABILITY, OR FITNESS FOR A PARTICULAR PURPOSE WHETHER ARISING FROM STATUTE, COMMON LAW, CUSTOM OR OTHERWISE. NO EXPRESS OR IMPLIED WARRANTY TO THE CUSTOMER SHALL EXTEND BEYOND THE PERIOD SPECIFIED IN A(1) ABOVE. THIS LIMITED WARRANTY SHALL BE THE EXCLUSIVE REMEDY AVAILABLE TO ANY PERSON.
 - (3) The exclusions and limitations set out above are not intended to, and should not be construed so as to contravene mandatory provisions of

¹ This Limited Warranty is provided by Arterioocyte Medical Systems, Inc., 45 South Street, Hopkinton, MA 01748 USA. It applies only in the United States. Areas outside the United States should contact their local Arterioocyte Medical Systems representative for exact terms of the Limited Warranty.

4 x 6.5 inches (101.6 mm x 165.1 mm)

applicable law. If any part or term of this Limited Warranty is held to be illegal, unenforceable or in conflict with applicable law by a court of competent jurisdiction, the validity of the remaining portions of the Limited Warranty shall not be affected, and all rights and obligations shall be construed and enforced as if this Limited Warranty did not contain the particular part or term held to be invalid. This Limited Warranty gives the customer specific legal rights. The customer may also have other rights which vary from state to state.

- (4) No person has any authority to bind Arterioocyte Medical Systems to any representation, condition or warranty except this Limited Warranty.

4 x 6.5 inches (101.6 mm x 165.1 mm)

DISPOSABLES LIMITED WARRANTY – ARTERIOCYTE MEDICAL SYSTEMS, INC. (OUTSIDE U.S.)

THE FOLLOWING **LIMITED WARRANTY** APPLIES TO CUSTOMERS OUTSIDE THE UNITED STATES.

- A. This LIMITED WARRANTY provides assurance for the customer who receives an Arterioocyte Medical Systems ® ("AMS") **Magellan® Ratio Dispenser Kit** "Product", that should the Product fail to function to specification, AMS will issue a credit equal to the original Product purchase price (but not to exceed the value of the replacement Product) against the purchase of any AMS replacement Product used for that customer. THE WARNINGS CONTAINED IN THE PRODUCT LABELLING ARE CONSIDERED AN INTEGRAL PART OF THIS LIMITED WARRANTY. CONTACT YOUR LOCAL AMS REPRESENTATIVE TO OBTAIN INFORMATION ON HOW TO PROCESS A CLAIM UNDER THIS WARRANTY.
- B. To qualify for the LIMITED WARRANTY, these conditions must be met:
- (1) The Product must be used prior to its "Use By" date.
 - (2) The Product must be returned to AMS within sixty (60) days after use and shall be the property of AMS.
 - (3) The Product must not have been altered or subjected to misuse, abuse or accident.
 - (4) The Product must not have been used more than one time for any customer.
 - (5) The Product must be used in conformity with the user instructions in the "User Manual" delivered to the customer together with the Product, of which this LIMITED WARRANTY is an integral part.
- C. This LIMITED WARRANTY is limited to its express terms. In particular:
- (1) In no event shall any replacement credit be granted where there is evidence of improper handling, improper use or material alteration of the replaced Product.
 - (2) AMS is not responsible for any incidental or consequential damages based on any use, defect or failure of the Product, whether the claim is based on warranty, contract, tort, patent infringement or otherwise.
- D. This LIMITED WARRANTY does not cover those parts that, by their very nature, are likely to deteriorate or which AMS considers should be periodically replaced consistently with normal routine or preventative maintenance requirements.
- E. The exclusions and limitations set out above are not intended to, and should not be construed so as to, contravene mandatory provisions of applicable law. If any part to term of this LIMITED WARRANTY is held by any court of competent jurisdiction to be illegal, unenforceable, or in conflict with applicable law, the validity of the remaining portion of the LIMITED WARRANTY shall not be affected, and all rights and obligations shall be construed and enforced as if this LIMITED WARRANTY did not contain the particular part or term held to be invalid.
- F. No representative, agent, dealer, retailer, or intermediary of AMS shall have authorization to amend the contents of this LIMITED WARRANTY.
- G. The validity, interpretation and performance of the agreement for which this LIMITED WARRANTY is issued, as well as any disputes relating or connected thereto is controlled by and construed under the laws of the State of Ohio, USA.

AMS Confidential

4 x 6.5 inches (101.6 mm x 165.1 mm)

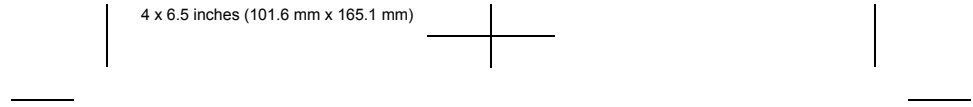

AMS95125LBL Rev. 2

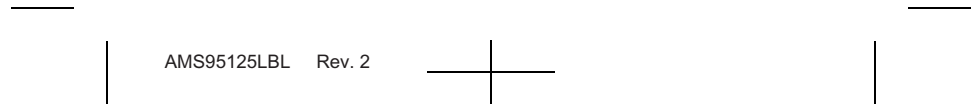

AMS Confidential

4 x 6.5 inches (101.6 mm x 165.1 mm)

ARTERIOCYTE
CELLULAR THERAPIES
MEDICAL SYSTEMS

Manufacturer:

Arterioocyte Medical Systems, Inc.
45 South St.
Hopkinton, MA 01748
USA
Internet: www.arterioocyte.com
Toll-free USA: 1-866-660-AMSI(2674)
Fax: 1-508-497-8951

© Arterioocyte Medical Systems, Inc. 2011
All Rights Reserved
AMS95125LBL Rev. 2

AMS95125LBL Rev. 2